

# WorkHorse Monitor ADCP User's Guide

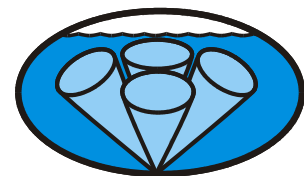

P/N 957-6165-00 (April 2005)



**RD Instruments**  
*Acoustic Doppler Solutions*



# Table of Contents

---

<b>1</b>	<b>Introduction</b> .....	<b>1</b>
<b>2</b>	<b>WorkHorse Monitor ADCP Applications</b> .....	<b>2</b>
<b>3</b>	<b>System Overview</b> .....	<b>4</b>
3.1	Monitor ADCP Overview .....	4
3.2	I/O Cable Overview.....	6
3.3	RS-232 to RS-422 Converter Overview .....	7
3.4	WorkHorse Monitor Options.....	7
3.4.1	Optional External Battery Pack .....	7
3.4.2	Optional Flash Memory Card .....	8
3.5	Spare Parts .....	8
<b>4</b>	<b>WorkHorse Care</b> .....	<b>9</b>
4.1	General Handling Guidelines .....	9
4.2	Assembly Guidelines .....	10
4.3	Deployment Guidelines.....	10
<b>5</b>	<b>Setup the WorkHorse Monitor ADCP</b> .....	<b>11</b>
5.1	Serial Communication .....	11
5.2	What if the WorkHorse Does Not Respond.....	11
<b>6</b>	<b>Software</b> .....	<b>12</b>
6.1	System Requirements.....	12
6.2	Software Installation.....	12
<b>7</b>	<b>Power</b> .....	<b>13</b>
7.1	AC Adapter .....	13
7.2	External Battery Pack .....	13
7.3	Bench-Top Battery Power Requirements.....	15
7.4	Operation Modes .....	15
<b>8</b>	<b>Testing Your WorkHorse</b> .....	<b>16</b>
<b>9</b>	<b>Compass Calibration</b> .....	<b>17</b>
9.1	Preparing for Calibration .....	17
9.2	Compass Calibration Verification .....	18
9.3	Compass Calibration Procedure .....	19
<b>10</b>	<b>Internal Pressure Sensor</b> .....	<b>21</b>
10.1	Pressure Sensor Maintenance.....	21
<b>11</b>	<b>Deployment Guide</b> .....	<b>22</b>
11.1	Deployment Checklist .....	22
11.2	Prepare the ADCP for Deployment .....	23
11.3	Deployment Software.....	23
11.4	Deploy the ADCP .....	24
11.5	Send the Deployment Commands .....	25
<b>12</b>	<b>Reviewing the Data</b> .....	<b>25</b>
12.1	'Where' was the Data? .....	25
12.2	'When' was the Data? .....	25
12.3	'What' is the Data? .....	25
<b>13</b>	<b>A Few Principles of Operation</b> .....	<b>26</b>
<b>14</b>	<b>Technical Support</b> .....	<b>27</b>

## List of Figures

---

Figure 1.	Monitor ADCP Overview.....	5
Figure 2.	Connecting and Disconnecting the I/O Cable.....	6
Figure 3.	I/O Cable Overview.....	6
Figure 4.	25-pin to 9-pin RS-232 to RS-422 Converter.....	7
Figure 5.	Memory Card Overview.....	8
Figure 6.	WorkHorse Monitor Connections.....	11
Figure 7.	External Battery Pack Connection.....	14
Figure 8.	BBTalk Command History Box.....	18
Figure 9.	Compass Alignment.....	20
Figure 10.	Visual Inspection before Deployment.....	22
Figure 11.	Prepare the ADCP.....	23
Figure 12.	Real-Time Deployment.....	24

## List of Tables

---

Table 1:	WorkHorse Real-Time Application Guide.....	2
Table 2:	WorkHorse Special Applications.....	2
Table 3:	WorkHorse Self-Contained Application Guide.....	3
Table 4:	Spare Parts.....	8
Table 5:	WorkHorse Software Main Modules.....	12
Table 6:	WorkHorse ADCP Tests.....	16

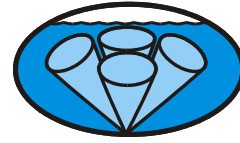

RD Instruments  
Acoustic Doppler Solutions

---

# WorkHorse Monitor ADCP User's Guide

---

## 1 Introduction

Thank you for purchasing the RD Instruments (RDI) WorkHorse. This booklet is designed to help first time WorkHorse users to set up, test, and deploy their ADCP.

This booklet is designed for use *with* the other WorkHorse Technical Manual books. Where needed, there are references to detailed information and figures contained in the WorkHorse Technical Manual.

WorkHorse Monitor deployments are most often Real-Time but can be Self-Contained. Real-Time use refers to the fact you are viewing the data as the ADCP collects it via a personal computer. This data is also stored on the computer to allow for data playback and processing at a later time.

Typically, deployments are considered to be Self-Contained when the ADCP is remotely deployed and powered using the optional External Battery Pack or from shore. When power is provided from shore, the deployment is still considered Self-Contained, but this quick reference guide may not consider all of the possibilities of this application.



**NOTE.** When you receive your WorkHorse, look for a set up card that shows all of the pieces you should have in your box. If anything is missing or damaged, contact RDI immediately.



**NOTE.** When an addition or correction to the manual is needed, an Interim Change Notice (ICN) will be posted to our web site on the Customer Service page ([www.rdiinstrument.com](http://www.rdiinstrument.com)). Please check our web site often.

## 2 WorkHorse Monitor ADCP Applications

The WorkHorse Monitor ADCP is the direct-reading version of RDI's Workhorse Sentinel ADCP. The Monitor ADCP is usually bottom frame-mounted and hard-wired back to shore to give real time monitoring of coastal currents. This makes it a favorite for deployment in high-volume traffic regions in ports, where it is an ideal component of a Vessel Traffic Monitoring System. When considering real time applications, RDI offers you choices in software packages that are intended to directly meet your needs. *VmDas* is the most often used software package for ADCP setup, real-time data collection, and data review. For detailed information on how to use *VmDas*, see the [VmDas User's Guide](#).

**Table 1: WorkHorse Real-Time Application Guide**

Application	Blue Water	Costal and Continental Shelf
Real-Time deployment	<b>Monitor using VmDas</b> <ul style="list-style-type: none"> <li>Oil production platforms</li> <li>Current mapping</li> </ul>	<b>Monitor using VmDas</b> <ul style="list-style-type: none"> <li>Port and harbor monitoring</li> <li>Water quality studies</li> </ul>
Boat Mount (portable)	<b>Monitor using VmDas</b> <ul style="list-style-type: none"> <li>Oceanography</li> <li>Boundary layer studies</li> <li>Fisheries</li> <li>Plankton biomass</li> </ul>	<b>Monitor using VmDas</b> <ul style="list-style-type: none"> <li>Plume tracking</li> <li>Environmental surveys</li> <li>Planning new ports</li> <li>Current mapping</li> </ul>
Towed	<b>Monitor using VmDas</b> <ul style="list-style-type: none"> <li>Towed fish positioning</li> <li>Boundary layer studies</li> <li>Circulation/model studies</li> </ul>	<b>Monitor using VmDas</b> <ul style="list-style-type: none"> <li>Towed fish positioning</li> <li>Water quality studies</li> </ul>
Offshore oil and gas	<b>Monitor using VmDas</b> <ul style="list-style-type: none"> <li>Seismic prospecting</li> <li>Exploration drilling</li> <li>Field development</li> <li>Production</li> </ul>	

**Table 2: WorkHorse Special Applications**

Monitor using WinRiver	Monitor using Waves
<ul style="list-style-type: none"> <li>River, stream and channel discharge</li> <li>Suspended sediment load estimation</li> <li>Plume tracking</li> <li>Bridge scouring</li> <li>Simultaneous bathymetry discharge, flow structure</li> </ul>	<ul style="list-style-type: none"> <li>Coastal protection and engineering</li> <li>Port design and operation</li> <li>Environmental monitoring</li> <li>Shipping safety</li> </ul>



**NOTE.** For information on how to use a Monitor in river discharge measurements, see the *WinRiver* User's Guide. For information on how to use a Monitor to monitor waves, see the *Waves* User's Guide.

The WorkHorse Monitor ADCP can be used as a fully self-contained system. This means that it uses the optional external battery case for power and internal recorder with optional flash memory for the storage of all data that you have set it up to collect. Using the optional external battery and recorder, the WorkHorse Monitor can be used for several-month autonomous current profile deployments from temporary or permanent mounting in the ocean, near-shore, harbors, and lakes.

*WinSC* is the software package for self-contained ADCP setup, data collection, and data review. For detailed information on how to use *WinSC*, see the [WinSC and PlanADCP User's Guide](#). *PlanADCP* (part of *WinSC*) lets you enter known or "best-guess" values for the various ADCP profiling parameters and shows predictions of expected results. For detailed information on how to use *PlanADCP*, see the [WinSC and PlanADCP User's Guide](#).

**Table 3: WorkHorse Self-Contained Application Guide**

Application	Blue Water	Costal and Continental Shelf
Autonomous deployment	<b>Monitor using WinSC</b> <ul style="list-style-type: none"> <li>• Oceanography</li> <li>• Energy transport</li> <li>• Environmental monitoring</li> <li>• Engineering stress determination</li> <li>• Circulation/model studies</li> <li>• Boundary layer studies</li> </ul>	<b>Monitor using WinSC</b> <ul style="list-style-type: none"> <li>• Environmental monitoring</li> <li>• Costal engineering</li> <li>• Enabling safe movement</li> <li>• Measuring Power plant discharge</li> <li>• Protecting coastal land forms</li> <li>• Detecting sewer outfall</li> <li>• Monitoring sensitive environments</li> <li>• Planning new ports</li> </ul>
Lowered	<b>Monitor using WinSC</b> <ul style="list-style-type: none"> <li>• Deep water oceanography</li> </ul>	



**NOTE.** *WinSC* is not provided with WorkHorse Monitor systems, but is available for free download at [www.rdinstruments.com](http://www.rdinstruments.com).

## 3 System Overview

The Monitor ADCP system consists of an ADCP, cables, RS-232-to-RS-422 converter, and software. They only require the addition of a Windows® compatible computer to collect data.

The Monitor can also be used for self-contained current profile operation by adding the external battery case and flash memory. Both battery capacity and memory can be increased with upgrades for longer deployments.

### 3.1 Monitor ADCP Overview

The transducer assembly contains the transducer ceramics and electronics. Standard acoustic frequencies are 300, 600, and 1200kHz. See the outline drawings in the [Installation Guide](#) for dimensions and weights.

**I/O Cable Connector** – Input/Output (I/O) cable connects the WorkHorse ADCP to the computer.

**Beam-3 Mark** – The Beam-3 mark shows the location of Beam-3 (Forward).

**Urethane Face** – The urethane face covers the transducer ceramics. Never set the transducer on a hard surface. The urethane face may be damaged.

**Housing** – The standard WorkHorse housing allows deployment depths to 200 meters.

**Thermistor** – The Thermistor measures the water temperature.

**Pressure Sensor** – The Optional pressure sensor measures water pressure (depth).

**Transducer Head** – The WorkHorse electronics and transducer ceramics are mounted to the transducer head. The numbers embossed on the edge of the transducer indicates the beam number. When assembling the unit, match the transducer beam number with the Beam 3 mark on the end-cap.

**End-Cap** – The end-cap holds the I/O cable connector. When assembling the unit, match the Beam 3 mark on the end-cap with beam 3 number on the transducer.



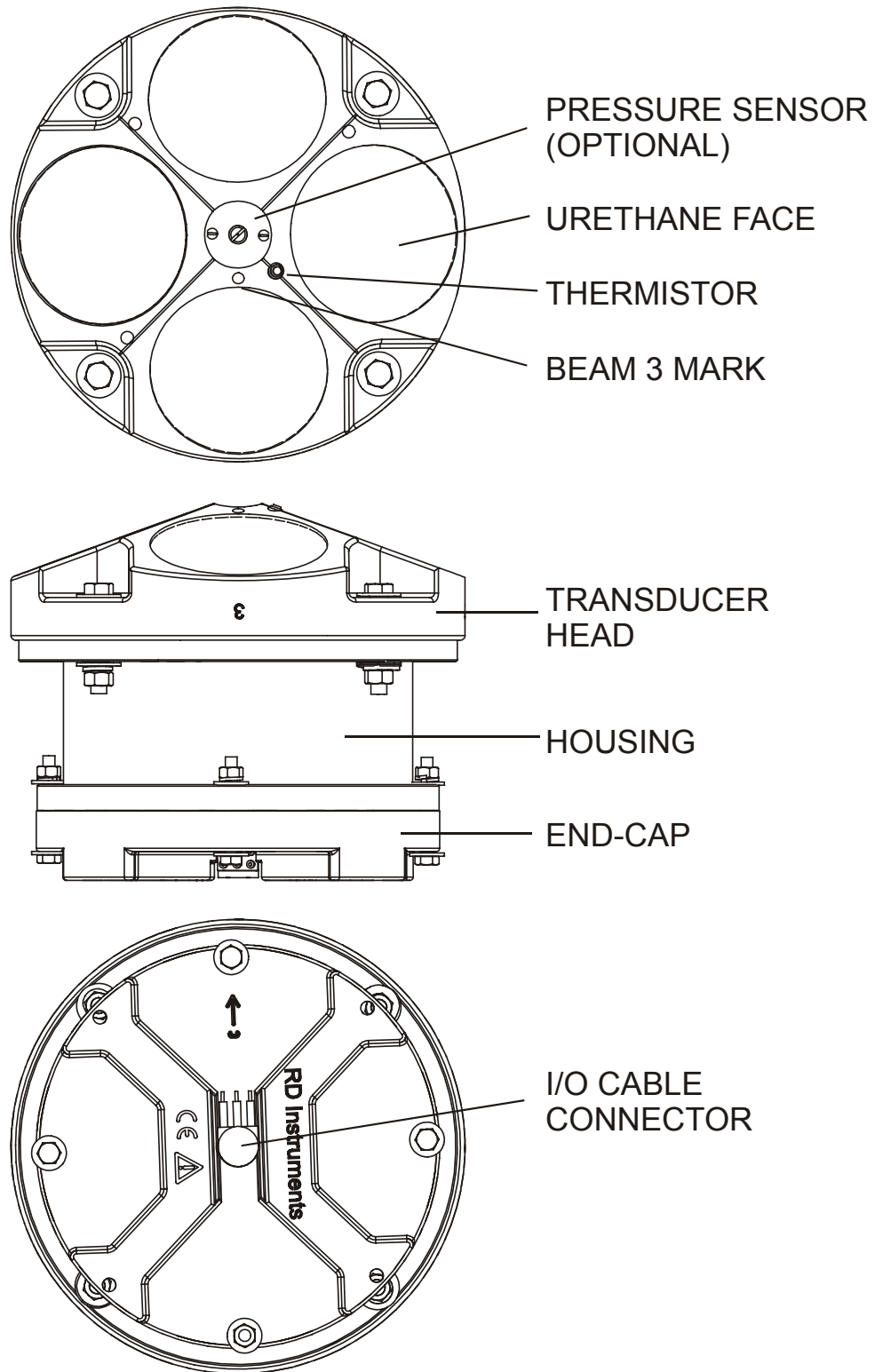

Figure 1. Monitor ADCP Overview

### 3.2 I/O Cable Overview

Always remove the retaining strap on the end-cap underwater-connect cable and dummy plug when disconnecting them. **Failure to do so will break the retainer strap.**

Do not apply any upward force on the end-cap connector as the I/O cable is being disconnected. **Stressing the end-cap connector may cause the ADCP to flood.** Read the [Maintenance guide](#) for details on disconnecting the I/O cable.

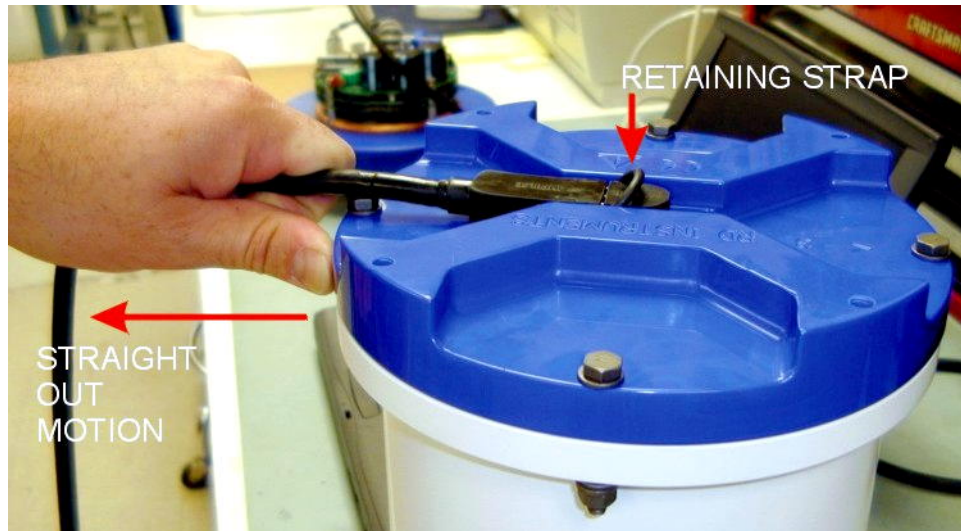

Figure 2. Connecting and Disconnecting the I/O Cable

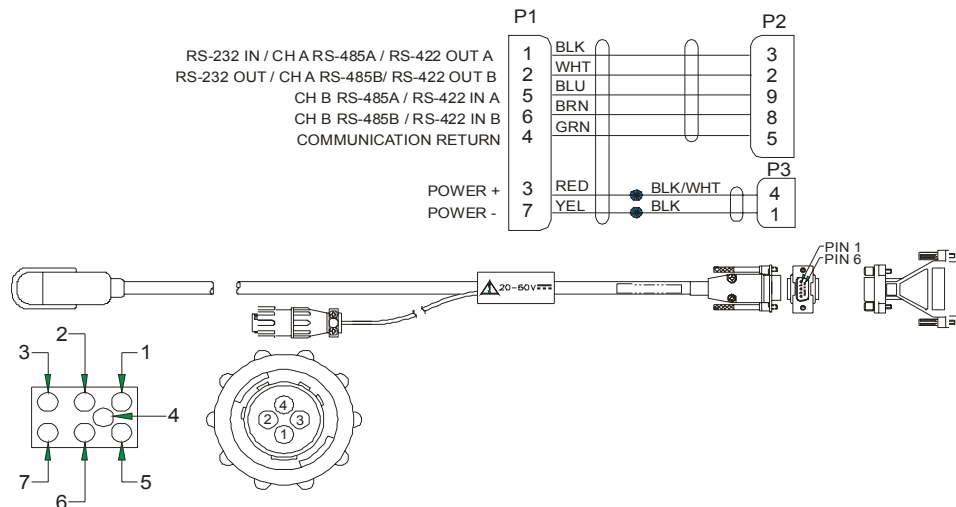
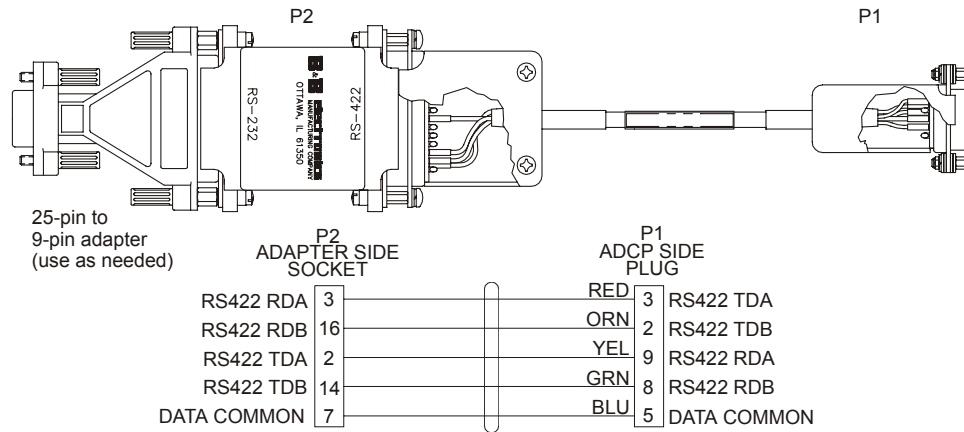



Figure 3. I/O Cable Overview

### 3.3 RS-232 to RS-422 Converter Overview

The adapter converts RS-232-to-RS-422. This adapter (includes cable) is supplied with the Monitor Workhorse.



**Figure 4. 25-pin to 9-pin RS-232 to RS-422 Converter**

 **NOTE.** The converter supplied with the WorkHorse is powered by the computer's COM port. It may be necessary to use a different converter when very long communication lines are used (maximum 1300 meters).

### 3.4 WorkHorse Monitor Options

The Monitor can also be used for self-contained current profile operation by adding the optional External Battery Pack and optional flash memory. Both battery capacity and memory can be increased with upgrades for longer deployments.

#### 3.4.1 Optional External Battery Pack

The optional External Battery Pack (Figure 7, page 14) can be used for backup power or to provide power for self-contained deployments. It consists of a housing, two 400 watt-hours batteries, blank end-cap, end-cap with female 7-pin connector, and External Battery Pack cable.

### 3.4.2 Optional Flash Memory Card

Memory cards are not included with the Monitor ADCP. Two PCMCIA memory card slots (see [Figure 5, page 8](#)) are available, with the total memory capacity not to exceed 2GB. The PC Card recorder is located on the Digital Signal Processor (DSP) board inside the Workhorse's electronics. To recover data, the card can be removed and used in a personal computer (PC), or left in the Workhorse, and accessed by using *WinSC* (see the [Software guide](#)).

 **NOTE.** The WorkHorse Monitor does not come with flash memory, but has the same capacity as a WorkHorse Sentinel.

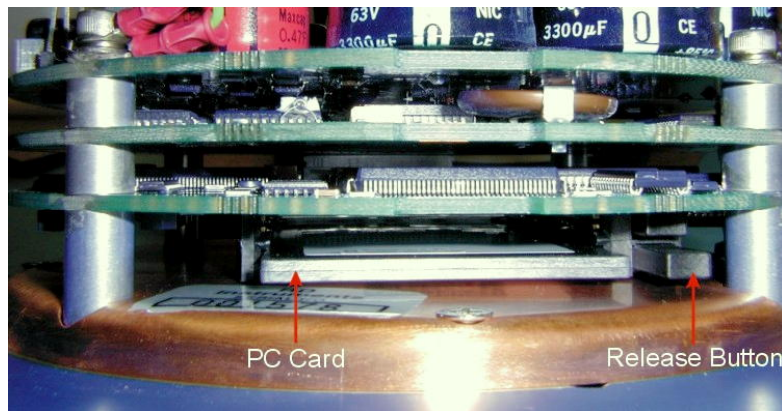

Figure 5. Memory Card Overview

### 3.5 Spare Parts

The following parts are included in the spare parts kit.

**Table 4: Spare Parts**

Description	Part number
O-ring, face	2-260
Desiccant, sealed bag	DES3
Lubricant, silicone, 5.3 oz, Dow-Corning	DC-111
Fuse, 3.0 Amp, 250V	GMA-3A

## 4 WorkHorse Care

This section contains a list of items you should be aware of every time you handle, use, or deploy your WorkHorse. *Please refer to this list often.*

### 4.1 General Handling Guidelines

- Never set the transducer on a hard or rough surface. **The urethane faces may be damaged.**
- Always remove the retaining strap on the end-cap underwater-connect cable and dummy plug when disconnecting them. **Failure to do so will break the retainer strap.**
- Do not apply any upward force on the end-cap connector as the I/O cable is being disconnected. **Stressing the end-cap connector may cause the ADCP to flood.** Read the [Maintenance guide](#) for details on disconnecting the I/O cable.
- Do not expose the transducer faces to prolonged sunlight. **The urethane faces may develop cracks.** Cover the transducer faces on the Workhorse if it will be exposed to sunlight.
- Do not expose the I/O connector to prolonged sunlight. **The plastic may become brittle.** Cover the connector on the Workhorse if it will be exposed to sunlight.
- Do not store the ADCP in temperatures over 60 degrees C with the batteries removed. **The urethane faces may be damaged.** Check the temperature indicator inside the shipping case. It changes color if the temperature limit is exceeded.
- Store batteries in a **cool dry location** (0 to 21 degrees C). If the batteries are installed in the ADCP, do not store the ADCP in temperatures over 21 degrees C.
- Do not store batteries inside the ADCP for extended periods. **The batteries may leak.**
- Use batteries within one year. **Batteries stored for more than 12 months should NEVER be used!**
- Vent the system before opening by loosening the end-cap. **If the ADCP flooded with batteries installed, there may be gas under pressure inside the housing.**
- Do not scratch or damage the O-ring surfaces or grooves. **If scratches or damage exists, they may provide a leakage**

**path and cause the ADCP to flood.** Do not risk a deployment with damaged O-ring surfaces.

- Do not lift or support a WorkHorse by the external I/O cable. **The connector or cable will break.**

## 4.2 Assembly Guidelines

- Read the [Maintenance guide](#) for details on WorkHorse re-assembly. Make sure the housing assembly O-rings stay in their groove when you re-assemble the WorkHorse. Tighten the hardware as specified. **Loose, missing, stripped hardware, or damaged O-rings can cause the WorkHorse transducer to flood.**
- Place a light amount of DC-111 lubricant on the end-cap connector pins (rubber portion only). **This will make it easier to connect or remove the I/O cable and dummy plug.**
- Do not connect or disconnect the I/O cable with power applied. An exception to this is the external battery case. The external battery case connector is always “hot” when batteries are installed. When you connect the cable with power applied, you may see a small spark. **The connector pins may become pitted and worn.**
- Do not attach a Workhorse Monitor or Sentinel I/O cable or power supply to the Workhorse Rio Grande ADCP. The Workhorse Mariner, Monitor and Sentinel ADCPs are 24 VDC systems. **The Workhorse Rio Grande uses 12VDC only.**
- The WorkHorse I/O cable is *wet mate-able*, not *under water mate-able*.

## 4.3 Deployment Guidelines

- Read the appropriate WorkHorse User's Guide and the Software User's Guides. **These guides have tutorials to help you learn how to use the ADCP.**
- Align the compass whenever the battery pack or recorder module is replaced, or when any ferrous metals are relocated inside or around the WorkHorse housing. **Ferro-magnetic materials affect the compass.**
- The AC power adapter is not designed to withstand water. **Use caution when using on decks in wet conditions.**

- Avoid using ferro-magnetic materials in the mounting fixtures or near the WorkHorse. **Ferro-magnetic materials affect the compass.**

## 5 Setup the WorkHorse Monitor ADCP

Figure 6 illustrates how to connect the WorkHorse cables and adapters on your workbench. The internal battery plugs into a connector on the top circuit board.

You will need a container of water large enough to submerge the WorkHorse's transducer head into during testing (two to three inches of water is sufficient). Testing the WorkHorse out of water may cause some tests to fail but causes no harm to the WorkHorse.

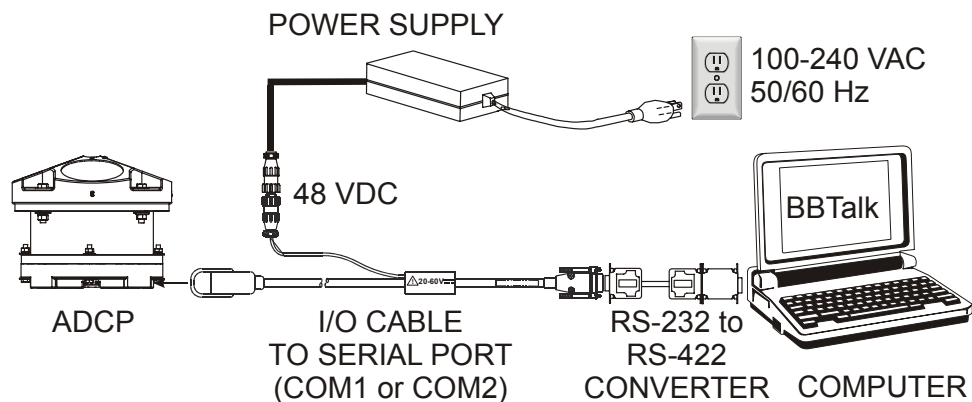

Figure 6. WorkHorse Monitor Connections

### 5.1 Serial Communication

The standard communications settings for WorkHorse Monitors is RS-422, 9600-baud, no parity, 8 data bits and 1 stop bit. If the serial protocol is set for RS422 and your computer expects RS232, you will need an RS232 to RS422 adapter between the WorkHorse cable and your computer. You can set the WorkHorse for baud rates other than 9600 baud.

**RS232.** The WorkHorse Monitor is normally set for RS422, but it can be changed to RS232 by changing a switch setting. The switch is in plain view on the top circuit board, near the cable connectors. Its settings are plainly marked on the board. This user's guide assumes that you use RS422.

### 5.2 What if the WorkHorse Does Not Respond

If your WorkHorse does not respond, check the serial port, cables, power, and RS-232 to RS-422 converter. If necessary, refer to the [Troubleshooting Guide](#) in the WorkHorse technical manual.

## 6 Software

RDI has utility programs to help you set up, use, test, and trouble-shoot your WorkHorse ADCP. Each program has a help file that you can print, or you can view help while running the program.

**Table 5: WorkHorse Software Main Modules**

Program Name	Description
<i>BBTalk</i>	Windows ADCP communication program. Use this program to "talk" to the ADCP and to run test script files. <i>BBTalk</i> is included on the RDI Tools CD. For detailed information on how to use <i>BBTalk</i> , see the RDI Tools User's Guide.
<i>WinADCP</i>	Gives users a visual display of the entire set of data. You can zoom in on a portion of the data for closer analysis and export data to text or MatLab files. For detailed information on how to use <i>WinADCP</i> , see the WinADCP User's Guide.
Documentation CD	The Documentation CD has an Adobe Acrobat® (*.pdf) electronic version of the WorkHorse Technical Manual. Use the Documentation CD to search for information. For detailed information on how to use Adobe Acrobat® and the Documentation CD, see the Read This First guide.



**NOTE.** See ["WorkHorse Monitor ADCP Applications," page 2](#) to see what software package to use for collecting data.

### 6.1 System Requirements

The WorkHorse software requires the following:

- Windows 95®, Windows 98®, Windows NT 4.0® with Service Pack 4 installed, Windows 2000®, or Windows XP®
- Pentium class PC 233 MHz (350 MHz or higher recommended)
- 32 megabytes of RAM (64 MB RAM recommended)
- 6 MB Free Disk Space (20 MB recommended)
- One Serial Port (two High Speed UART Serial Ports recommended)
- Minimum display resolution of 800 x 600, 256 color (1024 x 768 recommended)

### 6.2 Software Installation

To install the WorkHorse software, do the following.



- a. Insert the compact disc into your CD-ROM drive and then follow the browser instructions on your screen. If the browser does not appear, complete Steps “b” through “d.”
- b. Click the **Start** button, and then click **Run**.
- c. Type **<drive>:launch**. For example, if your CD-ROM drive is drive D, type **d:launch**.
- d. Follow the browser instructions on your screen

## 7 Power

The WorkHorse Monitor ADCP requires +20 to 50 VDC to operate. The standard AC Adapter runs on any standard AC power and supplies +48 VDC. The optional External Battery Pack provides +42 VDC.

If both the power supply and the optional External Battery Pack are connected, the Workhorse will select the *highest* voltage source for use. The AC Adapter input voltage is sufficient to override the internal battery voltage (i.e. the ADCP will draw all power from the AC adapter even if the battery is installed and connected).

All Workhorse tests and operations work equally well using the AC power adapter or optional external battery pack.

### 7.1 AC Adapter

The AC Adapter runs on any standard AC power and supplies 48 VDC to run the WorkHorse. Substitute your own power supply with a voltage of 45 to 50 VDC for deployments.



**NOTE.** Transmitted power increases or decreases depending on the input voltage. Higher voltage to the ADCP (within the voltage range of 20 to 50 VDC) will increase the transmitted power. The transmitted power is increased 6 DB if you double the input voltage from 24 VDC to 48 VDC. For a 300kHz WorkHorse ADCP, each additional DB will result in an increase in range of one default depth cell.

### 7.2 External Battery Pack

The optional External Battery Pack (see [Figure 7, page 14](#)) holds two 450 watt-hours (Wh) batteries. To avoid affecting the compass, place the external battery case at least 30-cm away from the Monitor WorkHorse.

Because many deployments will use only a fraction of the capacity of a single battery pack, you may wish to reuse your battery packs. With experience, you should be able to reuse batteries successfully, but keep in mind the following:

- Standard WorkHorse battery packs hold 28 'D-cell' alkaline batteries with a voltage, when new, of approximately 42 VDC.
- When the capacity of a battery pack is 50% used, the voltage (measured across the battery connector under no-load conditions) falls to approximately 32-35 volts. However, keep in mind that this voltage is not an accurate predictor of remaining capacity.
- Batteries should be replaced when the voltage falls below 30 VDC (measured across the battery connector under no-load conditions).
- Battery packs differ from one to another.
- Store batteries in a cool dry location (0 to 21 degrees C).
- Do not store batteries inside the ADCP for extended periods. The batteries may leak.
- Use batteries within one year (shelf life).

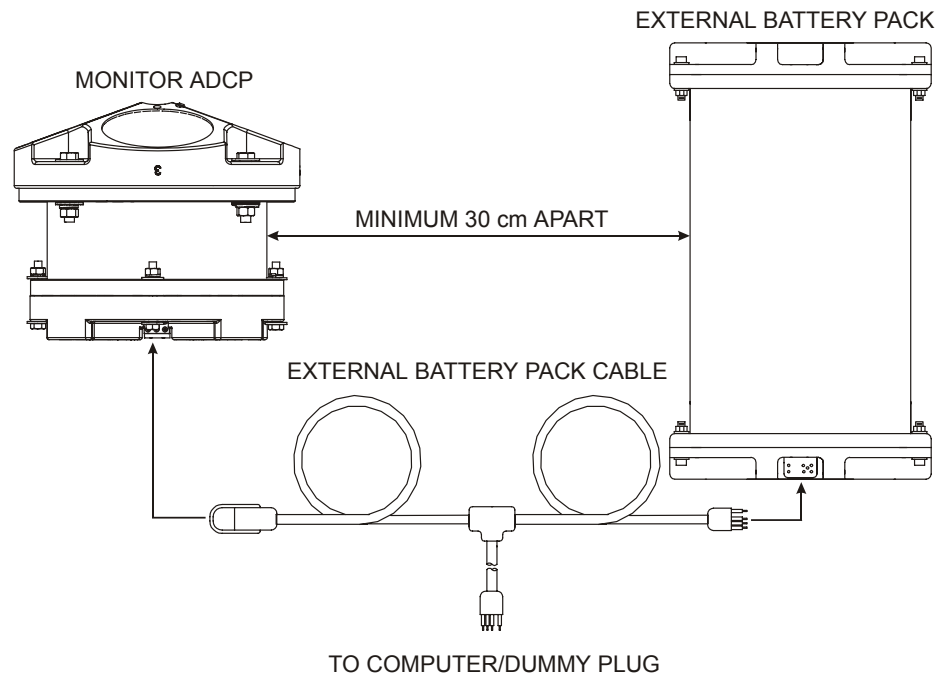

**Figure 7. External Battery Pack Connection**

## 7.3 Bench-Top Battery Power Requirements

While the WorkHorse is awake and responding to commands, it consumes approximately 2.2 watts. A single internal battery pack supplies this power level for about five days. When the WorkHorse is asleep, it consumes less than one mw. A standard battery pack supplies sleep power for years. At every opportunity, the WorkHorse will “sleep” to conserve power while deployed.

## 7.4 Operation Modes

The WorkHorse has two modes of operation: *command mode*, and *ping mode* (also referred to as “Deployment Saver” Mode). Depending on what mode the ADCP is in; it will go either to sleep or to resume pinging.

### **In the Command Mode**

Whenever you wake up your WorkHorse, power dissipation increases from less than one mw to around 2.2 w. If you leave the WorkHorse in command mode without sending a command for more than five minutes, the WorkHorse automatically goes to sleep. This protects you from inadvertently depleting batteries.

### **In the Ping Mode**

After you send commands to the WorkHorse that tells it to start collecting data, the WorkHorse goes into deployment saver mode. If power is somehow removed and later restored, the WorkHorse simply picks up where it left off and continues to collect data using the same setup.

## 8 Testing Your WorkHorse

Use the following steps to test the ADCP.

- a. Interconnect and apply power to the system as described in the “[Setup the WorkHorse Monitor ADCP](#),” page 11.
- b. Start the *BBTalk* program (for help on using *BBTalk*, see the [RDI Tools User's Guide](#)).
- c. Press <F2> and run the script file TestWH.rds. The TestWH.rds script file runs PS0, PS3, PA, PC2, and the PC1 tests. The results of the tests will be printed to the screen and saved to the log file WH\_RSLTS.txt. The WH\_RSLTS.txt file will be created in the same directory that *BBTalk* is running from.

[Table 7](#) lists the tests *BBTalk* runs, gives you guidelines for running the tests, and tells you what the results mean.

**Table 6: WorkHorse ADCP Tests**

Test	Guidelines	Results
PS0	Displays system parameters.	Verify the information is consistent with what you know about the setup of your system.
PA	Extensive pre-deployment test that tests the signal path and all major signal processing subsystems. This test may not pass unless the WorkHorse transducer face is immersed water.	All tests must pass.
PC2	Continuously updates sensor display. Rotate and tilt WorkHorse and watch the readings on the display change.	Satisfy yourself that the readings make sense.
PC1	Beam continuity test. Follow instructions to rub each beam in turn to generate a noise signal the WorkHorse uses to verify the transducer beam is connected and operational.	All beams must pass.

## 9 Compass Calibration

The main reason for compass calibration is battery replacement. Each new battery carries a different magnetic signature. The compass calibration algorithm corrects for the distortions caused by the battery to give you an accurate measurement. You should be aware of the following items:

- We recommend against calibrating the WorkHorse while on a ship. The ship's motion and magnetic fields from the hull and engine will likely prevent successful calibration.
- If you think your mounting fixture or frame has some magnetic field or magnetic permeability, calibrate the WorkHorse inside the fixture. Depending on the strength and complexity of the fixture's field, the calibration procedure may be able to correct it.

### 9.1 Preparing for Calibration

- a. Place the Workhorse on a piece of strong cardboard on top of a smooth wooden (non-magnetic) table. If a wooden table is not available, place the Workhorse on the floor as far away from metal objects as possible. Use the cardboard to rotate the Workhorse during calibration—this way you will not scratch the Workhorse. Place the ADCP in the same orientation as it will be deployed.



**NOTE.** If you will deploy your Workhorse looking up, calibrate it looking up. If you will deploy it looking down, calibrate it looking down.



**CAUTION.** If you calibrate the compass in one direction (up or down) and deploy the ADCP in the opposite direction (i.e. calibrate it in a downward position and deploy it in an upward position) the compass calibration will be invalid. Compass errors in excess of 5 degrees may occur.

- b. Connect the Workhorse as shown in [“Setup the WorkHorse Monitor ADCP,”](#) page 11.
- c. Start *BBTalk*. See the [RDI Tools User's Guide](#) for assistance on using *BBTalk*.

## 9.2 Compass Calibration Verification

Compass calibration verification is an automated built-in test that measures how well the compass is calibrated. The procedure measures compass parameters at every 5° of rotation for a full 360° rotation. When it has collected data for all required directions, the Workhorse computes and displays the results.



**NOTE.** Verify the compass if you have just replaced the memory module, or any ferrous metals is relocated inside or around the Workhorse housing. Calibrate the compass if the batteries have been replaced (see “Compass Calibration Procedure,” page 19).

- a. Prepare the ADCP for calibration (see “Preparing for Calibration,” page 17).
- b. Using *BBTalk*, send a Break to wake up the Workhorse.
- c. On the **Transfer** menu, click **Command History**. In the **Enter a Command** box, enter **AX** and click **OK**.

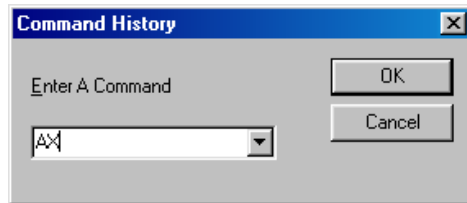

**Figure 8. BBTalk Command History Box**

- d. When prompted, rotate the Workhorse slowly 360 degrees (approximately 5 degrees per second). Pay particular attention to the Overall Error. For example;

```

HEADING ERROR ESTIMATE FOR THE CURRENT COMPASS CALIBRATION:
OVERALL ERROR:
  Peak Double + Single Cycle Error (should be < 5()): ( 1.55(
DETAILED ERROR SUMMARY:
  Single Cycle Error: ( 1.54(
  Double Cycle Error: ( 0.07(
  Largest Double plus Single Cycle Error: ( 1.61(
  RMS of 3rd Order and Higher + Random Error: ( 0.31(
    
```

If the overall error is less than 2°, the compass does not require alignment. You can align the compass to reduce the overall error even more (if desired).

## 9.3 Compass Calibration Procedure

The built-in automated compass calibration procedure is similar to the alignment verification, but requires three rotations instead of one. The Workhorse uses the first two rotations to compute a new calibration matrix and the third to verify the calibration. It will not accept the new matrix unless the calibration was carried out properly, and it asks you to verify that you want to use the new calibration if it is not as good as the previous calibration. While you are turning the Workhorse for the two calibration rotations, the Workhorse checks the quality of the previous calibration and displays the results. It compares these results with the results of the third calibration rotation.

There are two compass calibrations to choose from; one only corrects for hard iron while the other corrects for both hard and soft iron characteristics for materials rotating with the ADCP. Hard iron effects are related to residual magnetic fields and cause single cycle errors while soft iron effects are related to magnetic permeability that distorts the earth's magnetic field and causes double cycle errors. In general, the hard iron calibration is recommended because the effect of hard iron dominates soft iron. If a large double cycle error exists, then use the combined hard and soft iron calibration.

- a. Prepare the ADCP for calibration (see [“Preparing for Calibration,”](#) page 17).
- b. Using *BBTalk*, send a Break to wake up the ADCP.
- c. On the **Transfer** menu, click **Command History**. In the **Enter a Command** box, enter **AF** and click **OK**. When the calibration procedure starts, choose the calibration type.
- d. Tilt the ADCP (see [Figure 9, page 20](#)). Tilt an upward-looking Workhorse with a block under one side of the end-cap. A 35-mm block will give you an 11-degree tilt. Check the on-screen instructions to see if the orientation is OK. Adjust as necessary.



**NOTE.** The tilts must remain constant during the rotations. The transducer beam is the center point of the rotation.

- e. When prompted, rotate the ADCP slowly 360 degrees (approximately 5 degrees per second).
- f. The second rotation requires the ADCP to be tilted 15 degrees in another direction than from the first rotation (see [Figure 9, page 20](#)). Follow the on-screen instructions to orient the ADCP correctly. When prompted, rotate the ADCP slowly 360 degrees (approximately 5 degrees per second).

- g. The third rotation requires the ADCP to be tilted 15 degrees in another direction than from the first and second rotations. Follow the on-screen instructions to orient the ADCP correctly.
- h. If the calibration procedure is successful, it records the new calibration matrix to nonvolatile memory. The ADCP will not change its matrix unless the calibration is properly carried out.
- i. If the calibration procedure is not successful, return your ADCP to the original factory calibration, by using the AR-command. Try using the AR-command if you have trouble calibrating your compass. In some circumstances, a defective compass calibration matrix can prevent proper calibration.

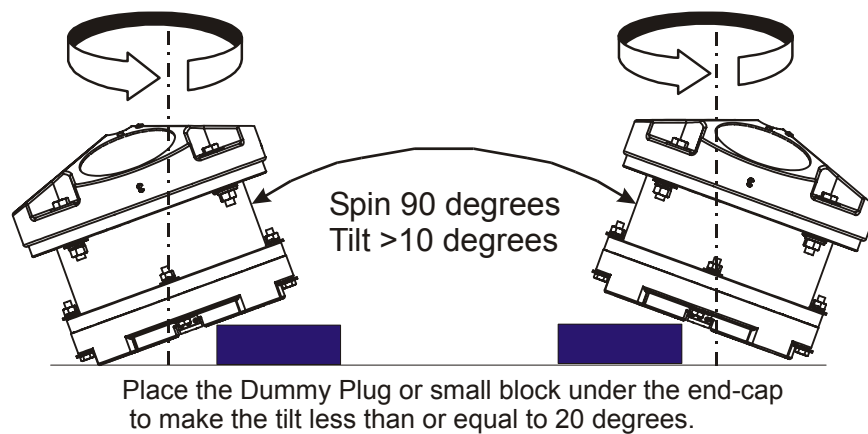

UPWARD DEPLOYMENT

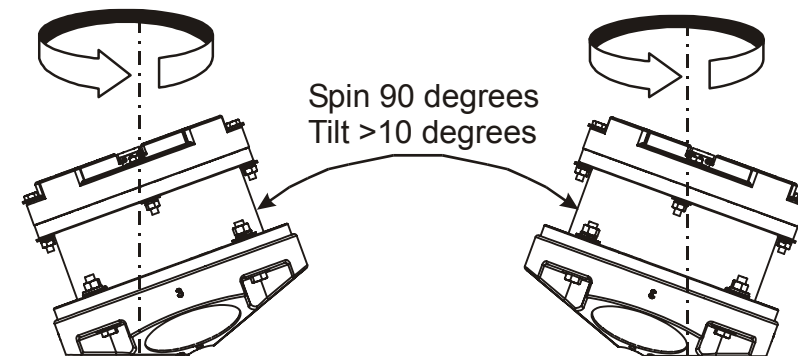

DOWNWARD DEPLOYMENT

**Figure 9. Compass Alignment**



## 10 Internal Pressure Sensor

If you have the optional pressure sensor installed in your ADCP, use the AZ-command to zero out the pressure sensor at the deployment site.

- a. Connect and apply power to the system as described in “[Setup the WorkHorse Monitor ADCP](#),” page 11.
- b. Start *BBTalk* and wakeup the ADCP (press the **END** key).
- c. Type **AZ** and press the **Return** key.
- d. Exit *BBTalk*.

### 10.1 Pressure Sensor Maintenance

In order to read the water pressure (depth), water must be able to flow through the copper screw on the pressure sensor. Antifoulant paint will block the sensor's port (a small hole that is drilled through the copper screw). You should tape off the screw during anti-fouling paint application.

This means that the sensor port is not fully protected from bio fouling. The sensor port is surrounded by the antifouling paint, but bio fouling may build up on the screw, and eventually clog the sensor port. However, most organisms do not seem to find the small amount of unpainted surface attractive. If it is logistically possible to periodically inspect/clean the pressure sensor screw, it is highly recommended. This tradeoff situation must be analyzed for individual deployments. Unfortunately, the location of the deployment site usually dictates action in this regard.



**NOTE.** The pressure sensor is optional. It may not be included on your system.



**CAUTION.**

The pressure sensor is filled with silicone oil. Never poke a needle or other object through the copper screw while the screw is installed over the pressure sensor. You will perforate the sensor, causing it to fail.

Do not remove the cover disc or attempt to clean the surface of the pressure sensor. The diaphragm is very thin and easy to damage.

Do not remove the pressure sensor. It is not field replaceable.

# 11 Deployment Guide

Use the following steps and the Quick Reference card to setup the WorkHorse for a deployment.

## 11.1 Deployment Checklist

- ❑ Test the ADCP using *BBTalk*
- ❑ Seal the ADCP for deployment
  - ❑ Install new o-rings; use silicone lubricant
  - ❑ Use fresh desiccant (2 bags) inside ADCP
- ❑ Visually inspect the ADCP
  - ❑ Check the transducer head condition
  - ❑ Check the zinc anode condition (High Pressure Housing only)
  - ❑ Check the housing paint condition (High Pressure Housing only)
  - ❑ All mounting hardware installed
  - ❑ Transducer faces clean and free from defects
- ❑ Verify compass alignment using *BBTalk*; if necessary, re-calibrate
- ❑ Are biofouling precautions needed?
- ❑ Zero pressure sensor (optional) at deployment site with AZ-command

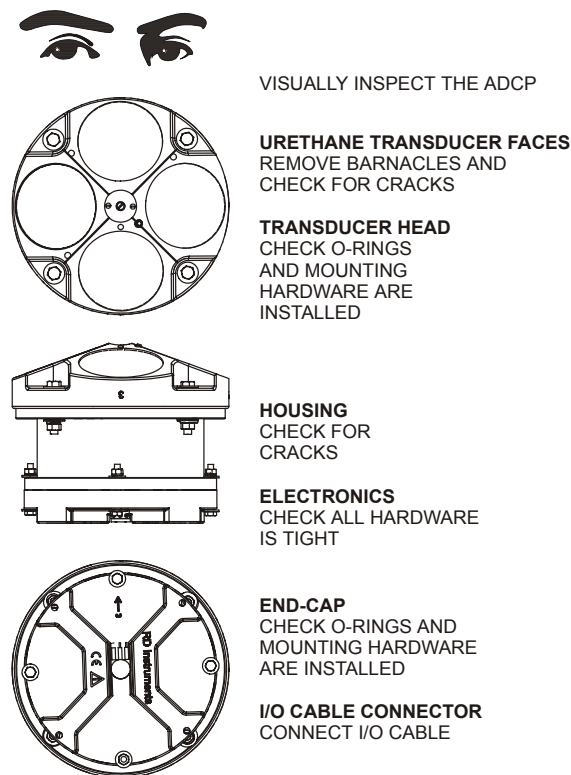

**Figure 10. Visual Inspection before Deployment**

## 11.2 Prepare the ADCP for Deployment

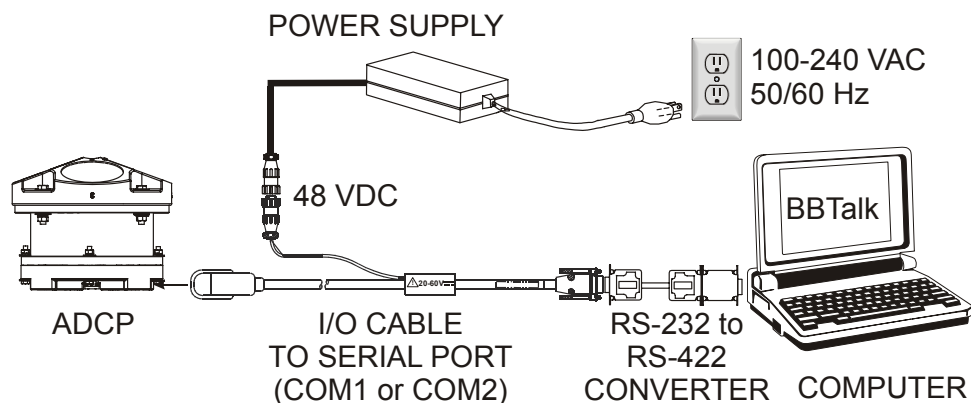

**Figure 11. Prepare the ADCP**

Things to remember while preparing the ADCP.

- Use the Deployment Checklist to verify that the ADCP is ready for the deployment.
- Test the ADCP using *BBTalk*. Some tests will fail if the ADCP is not placed in water while the tests are being run.
- *Desiccant* lasts a year at specified WorkHorse deployment depths and temperatures. Remember that desiccant rapidly absorbs moisture from normal room air. Replace the desiccant whenever the WorkHorse housing or end-cap is removed.
- Verify the compass calibration.

## 11.3 Deployment Software

Real-Time data collection involves a series of independent steps. Using RDI's Software will ensure that the ADCP is setup correctly.

- Test your WorkHorse (*BBTalk*)
- Plan your deployment (see [“WorkHorse Monitor ADCP Applications,” page 2](#) for what software program to use.)
- Transfer your “plan” into the WorkHorse and start data collection
- Verify data integrity
- Display and process your data

The RDI software is designed to allow you to set up your WorkHorse to get the best possible data without having to understand and use WorkHorse

commands. *VmDas*, *WinRiver*, and *Waves* help you create the commands necessary to deploy the ADCP.



**NOTE.** Refer to the *VmDas*, *Waves*, and *WinRiver* Guides for information on how to use these programs.

## 11.4 Deploy the ADCP

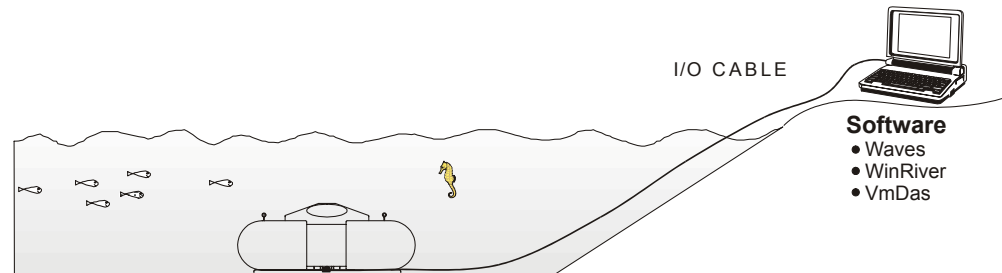

**Figure 12. Real-Time Deployment**

Things to remember while deploying the ADCP.

- For real-time data collection, especially over long cables, you should use a 48 to 50 VDC, 50 W power supply.
- *Tilts.* The Workhorse corrects data for tilts as large as 15°, but tilts reduce the effective range and increase the depth of surface contamination.
- *Anti-fouling paint.* You are free to use any anti-fouling paint or other anti-fouling material you wish over any surface of the Workhorse. However, you should consider the following:
  1. Ensure that your coating can be used safely on plastic in general and polyurethane specifically.
  2. Apply it thinly and evenly to the transducer faces.
  3. Poorly applied coatings on the transducer could adversely affect instrument performance.
- *Magnetic material.* Keep the Workhorse's compass away from magnetic material when you deploy the instrument. Check for magnetic fields by smoothly moving a compass around and near the Workhorse and its mounting frame.

## 11.5 Send the Deployment Commands

Use *VmDas*, *Waves*, or *WinRiver* (see the respective User's Guides) to send the commands to the ADCP.

Things to remember while deploying the ADCP.

- *Ping beeps*. Whenever the Workhorse pings, an internal beeper makes an audible beep. The beep consumes negligible energy and tells you the Workhorse is pinging.

## 12 Reviewing the Data

### 12.1 'Where' was the Data?

The quickest way to find out the depth of each depth cell is to display your recorded data using *WinADCP*. The velocity display tells you the distance to the center of each cell. The computed distance assumes that the speed of sound is constant from the transducer to the depth cell. The actual distance is proportional to the average sound speed; if the average sound speed is 1% less than the sound speed at the transducer, the distance to the depth cell is 1% less than the displayed distance.

### 12.2 'When' was the Data?

The time recorded with each data record is the time of the beginning of the first ping of the ensemble. *Plan* sets the ping interval so pings occur uniformly across the ensemble interval (as opposed to putting all the pings at the beginning of the interval). It leaves a few seconds at the end of each ensemble to allow time for data recording. Hence, the average time of the ensemble is midway between the recorded ensemble time and the time of the next ensemble.

### 12.3 'What' is the Data?

The WorkHorse records velocity data in units of mm/s. Calibration depends on how well the WorkHorse knew the speed of sound (which it computed based on its measured temperature and the salinity value it was given). A salinity error of 5 ppt introduces less than 0.5% velocity error.

## 13 A Few Principles of Operation

Consult RDI's Primer (ADCP Principles of Operation: a Practical Primer, Second Edition for BroadBand ADCPs) to learn more about WorkHorse principles of operation. The following are a few points from the Primer that may be worth knowing:

- Horizontal velocity measurement accuracy is unaffected by vertical stratification.
- Stratification has negligible affect on the ability of the WorkHorse to penetrate through the water; concentration of suspended particles is the main factor influencing profiling range.
- WorkHorse measurements are automatically corrected for tilts up to  $\pm 20^\circ$ . In addition to correcting for the beam pointing angles, the WorkHorse maps depth cells to other cells at the same depth.
- If you want to make measurements near the surface from a bottom-mounted WorkHorse, you should minimize the tilt.
- Depth cells are most sensitive to velocities at the center of the depth cell and less sensitive at the top and bottom. This sensitivity is reflected by what we call a 'triangular weighting function'. The details of this weighting function are rarely important for interpretation and use of your data.
- The actual maximum range can be different from the range predicted in *Plan*. *Plan* corrects for range variations caused by temperature and salinity, but it assumes typical scattering conditions. Weak backscatter can sometimes reduce range by a factor of two or more.
- In self-contained deployments, the maximum profiling range decreases with time as the battery voltage falls. This is because transmit power depends on battery voltage. Transmit power is optimized for about 32 volts. RDI's alkaline battery packs start at 42 VDC, but spend most of their useful lives within a few volts of 32 VDC.

## 14 Technical Support

If you have technical problems with your instrument, contact our field service group in any of the following ways:

### **RD Instruments**

9855 Businesspark Ave.  
San Diego, California 92131  
(858) 693-1178  
FAX (858) 695-1459  
Sales - [rdi@rdinstruments.com](mailto:rdi@rdinstruments.com)  
Field Service - [rdifs@rdinstruments.com](mailto:rdifs@rdinstruments.com)

### **RD Instruments Europe**

5 Avenue Hector Pintus  
06610 La Gaude, France  
+33(0) 492-110-930  
+33(0) 492-110-931  
[rdi@rdieurope.com](mailto:rdi@rdieurope.com)  
[rdifs@rdieurope.com](mailto:rdifs@rdieurope.com)

Web: [www.rdinstruments.com](http://www.rdinstruments.com)

After Hours Emergency Support - +1 858-578-0781

**NOTES**